

SANAYİ MAKİNALARI HAREKET VİDALARI  
INDUSTRIAL MACHINERY MOVING SCREWS



# KEYVAN

MAKİNA VİDA İMALATI  
MÜHENDİSLİK SAN. VE TİC. LTD. ŞTİ.



[www.keyvanvida.com](http://www.keyvanvida.com)



2007 yılında 160 m<sup>2</sup> lik atölyede Elvan Keyvan tarafından kurulan **KEYVAN MAKİNA**, geçen zaman içerisinde makina parkurunu genişleterek kapasite artırımı yapmış, hedeflediği müşteri ve iş potansiyeline ulaşmıştır. 2010 yılından beri **KEYVAN MAKİNA VİDA İmalatı Mühendislik San. ve Tic. Ltd. Şti.** olarak 1300 m<sup>2</sup> lik yeni yerinde yoluna devam etmektedir. Türkiye'de sanayi sektörünün beyni olan makinacılar ve yan sanayi ürünleri kavramında sabit iş düşüncesinin dışına çıkmak isteyen **KEYVAN MAKİNA**, dünya çapında girdiği pazarda lider firma olmak için sürekli yenilikler yapmaktadır. Daha geniş ürün yelpazesi ile siz değerli müşterilerimize daha iyi hizmet verebilmek için tüm imkanları kullanmaktadır. Çap 8 mm den başlayarak istenilen çapı boy ve hatve sınırı olmaksızın (1 modülden 30 modüle kadar vida) 1 mm den 2.000 mm ye kadar hatve yürütme imkanımız vardır. Ağız sayısı 120 ile sınırlıdır. Her türlü makina hareket vidaları yapılmaktadır.

Kısaca bazı çalışma alanlarımızdaki sektörler;

- Sanayi makinaları
- Mermer makinaları
- Marangoz makinaları
- Tekstil makinaları
- Gıda makinaları
- İnşaat makinaları
- Plastik makinaları
- Paketleme makinaları
- Asansör vidaları
- Torna, borvenk, freze ve
- Özel amaçlı vidalar

**KEYVAN MAKİNA**, which was founded by Elvan Keyvan in 2007 in a workshop of m<sup>2</sup> 160, has widened its machinery in the course of time, has increased its capacity and has reached its targeted customer and work potential. Since 2010 in a new workshop of m<sup>2</sup> 1300, it has been going on its activities under the name of **KEYVAN MAKİNA VİDA İmalatı Mühendislik San. ve Tic. Ltd. Şti. (Keyvan Machine Screw Manufacturing Engineering Industry and Trade Ltd.)**. **KEYVAN MAKİNA**, which aims to get out of classical business mentality within the scope of machinery and sub-industry products, which are the heart of industry in Turkey, makes continuous innovations to be a leader firm in the international market. It tries all possible ways to give better service to you, our valuable customers with a wider product range. We have the capacity of producing pitches from mm 1 to mm 2000, at the desired diameter and length beginning from mm 8 without pitch limit (screws from 1 module to 30 modules). The opening number is limited with 120. Every kind of machine power screws is manufactured.

Shortly, some sectors within the scope of our activity are:

- Industry machinery
- Marble machinery
- Wood working machines
- Textile machines
- Food processing machines
- Construction machines
- Plastic machines
- Packaging machines
- Elevator screws
- Lathe, "borvenk", milling and
- Special purpose screws



**KEYVAN**

MAKİNA VİDA İMALATI

MÜHENDİSLİK SAN. VE TİC. LTD. ŞTİ.



# TRAPEZ VİDALAR / ACME SCREWS



TR 40 X 10 X 6 AĞIZLI VİDA / START THREAD



TR 60 X 12 X 5 AĞIZLI VİDA / START THREAD



TR 24 X 14 SOL VİDA / LEFT HAND THREAD



TR 120 X 12 VİDA / SCREW



TR 120 X 12  
KONTROL MASTARI / CONTROL GAUGE

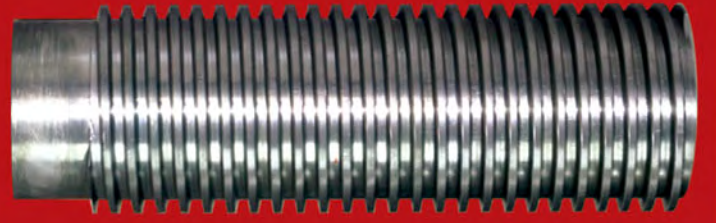

TR 180 X 20 VİDA / SCREW



TRAPEZ KONTROL MASTARI / ACME CONTROL GAUGE

|         |         |          |           |
|---------|---------|----------|-----------|
| Tr 10x2 | Tr 22x5 | Tr 40x6  | Tr 60x10  |
| Tr 10x3 | Tr 24x5 | Tr 40x7  | Tr 70x10  |
| Tr 12x3 | Tr 25x5 | Tr 42x7  | Tr 70x12  |
| Tr 14x4 | Tr 28x5 | Tr 45x8  | Tr 80x10  |
| Tr 16x3 | Tr 30x5 | Tr 48x8  | Tr 80x12  |
| Tr 16x4 | Tr 30x6 | Tr 50x8  | Tr 90x12  |
| Tr 18x4 | Tr 32x6 | Tr 50x10 | Tr 100x12 |
| Tr 20x4 | Tr 35x6 | Tr 55x10 | Tr 100x14 |
| Tr 20x5 | Tr 38x6 | Tr 60x9  | Tr 120x14 |

Bu listedeki ürünler sınırsız boyda 2-3-4 ağızlı, sağ ve sol olarak üretilmektedir.

Ayrıca isteğe göre Ø 280 mm'ye kadar her türlü hatvede özel trapez vida imalatı yapılmaktadır.

Products in this list are produced in unlimited length with right-hand and left-hand types and 2-3-4 start threads. Also, special acme screws can be manufactured in any pitch up to Ø 280 mm as per order.

# SONSUZ VİDALAR / WORM SCREWS



**7 MODÜL  
SONSUZ VİDA  
7 MODULE  
WORM SCREW**



**HELİS  
DİŞLİ  
HELICAL GEAR**



**2.5 MODÜL 4 AĞIZLI  
SONSUZ VİDA  
2.5 MODULE 4 START  
WORM SCREW**



**2.5 MODÜL 8 AĞIZLI  
SONSUZ VİDA  
2.5 MODULE 8 START  
WORM SCREW**



**10 MODÜL  
SONSUZ VİDA  
10 MODULE  
WORM SCREW**



**8 MODÜL 2 AĞIZLI  
AĞIR TİP SONSUZ VİDA  
8 MODULE 2 START  
HEAVY WORM SCREW**



**Ø 200 16 MODÜL  
SONSUZ VİDA  
Ø 200 16 MODULE  
WORM SCREW**

0,5 modülden 30 modüle kadar, Ø 10 mm ile 700 mm arası ağız sayısı sınırı olmaksızın her kalite malzemedен sonsuz vida imalatı yapılmaktadır. *Worm screws can be manufactured from materials of any quality with unlimited starts between Ø 10 mm and 700 mm from 0,5 to 30 modules.*

# HELEZON ÇEŞİTLERİ / SPIRALS



PLASTİK ENJEKSİYON (EKSTRÜLER) MİLİ / PLASTIC INJECTION (EKSTRUDER) SHAFT



SAĞ TAŞIMA HELEZONU / RIGHT-HAND SPIRAL



ÇİFT AĞIZLI VE ÇİFT YÖNLÜ TAŞIMA HELEZONU / DOUBLE-ENDED AND BI-DIRECTIONAL SPIRAL



SOL RADIUS HELEZON / LEFT RADIUS SPIRAL



GENİŞ HATVELİ HELEZON / WIDE PITCH SPIRAL

10 mm ile 250 mm arası her türlü malzemeden, sağ ve sol olarak istenilen hatvede helezon imalatı yapılmaktadır. *Spirals can be manufactured in any pitch with right-hand and left-hand types from all kinds of materials between 10 mm and 250 mm*

# HELEZON ÇEŞİTLERİ / SPIRALS



TAŞIYICI HELEZON  
CONVEYOR SCREW



KONİK ANKRAJ  
ELEMANI  
CONICAL ANCHOR



HELEZON  
SPIRAL

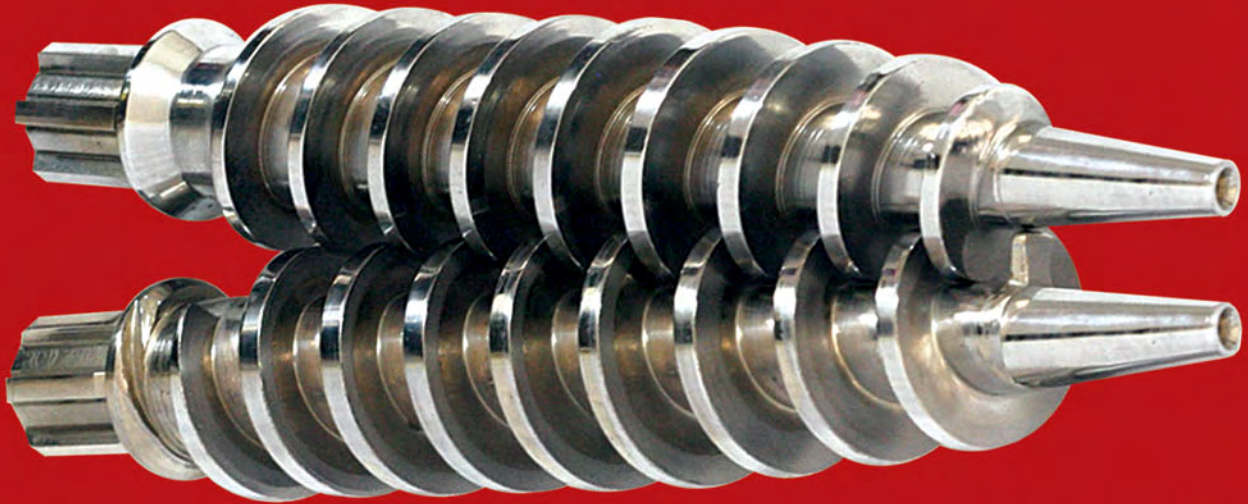

MANGAL KÖMÜRÜ SIKIŞTIRMA HELEZONU / CHARCOAL COMPRESSION SPIRAL

# ÖZEL VİDALAR / SPECIAL SCREWS



ÇİFT YÖNLÜ HALAT SARMA MİLİ / DOUBLE SIDED STRAND



ÇİFT YÖNLÜ HALAT SARMA MİLİ / DOUBLE SIDED STRAND



42'LİK MONOPOMP MİLİ / 42" MONOPOMP SCREW



VİDALI  
ÇEKTİRME KANCASI  
SCREW TOW HOOK

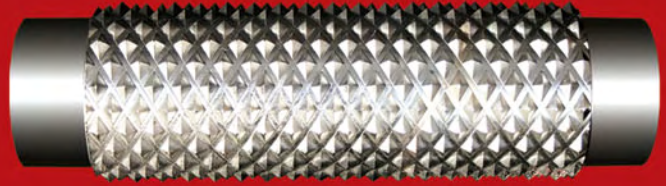

KIRICI / CRUSHER



GİJON / CONNECTOR



AĞAÇ İŞLEME  
FREZE BİÇAĞI  
WOODWORKING CUTTER

İsteğe göre her türlü özel vida imalatı yapılmaktadır.  
All kinds of customized screws can be manufactured as per order.



# ÖZEL VİDALAR / SPECIAL SCREWS



70'LİK ROTOR  
70 Tİ ROTOR



MARANGOZ MENGENESİ  
CARPENTER'S VİSE



80'LİK ROTOR  
80 Tİ ROTOR



ROTOR MİLİ / ROTOR SHAFT



HELİS DİŞLİ / HELICAL GEAR



Ø 450 x 3 AĞIZLI BORU / START PIPE

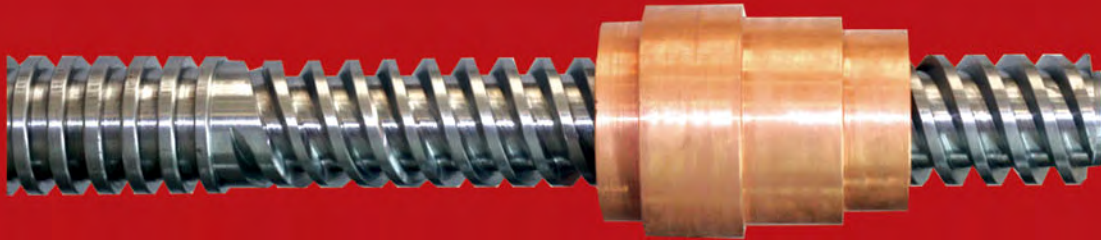

3 AĞIZLI FRIKSİYON PRES MİLİ VE SOMUNU / 3 START FRICTION PRESS SHAFT AND NUT

# MAKİNA VİDALARI / MACHINE SCREWS



SN-71 - SN-50 - 1 - 1.5 - 2 - 3 METRE ANA MİL / METER MAIN SHAFT



SN-71 ENİNE SPORT MİLİ / SN-71 TRANSVERSE SPORT SHAFT



SN-50 ENİNE SPORT MİLİ / SN-50 TRANSVERSE SPORT SHAFT

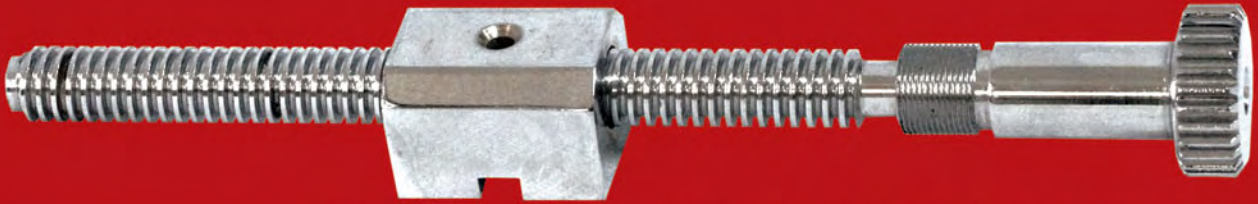

SN-50 ÇAPRAZ SPORT MİLİ / SN-50 CROSS SPORT SHAFT

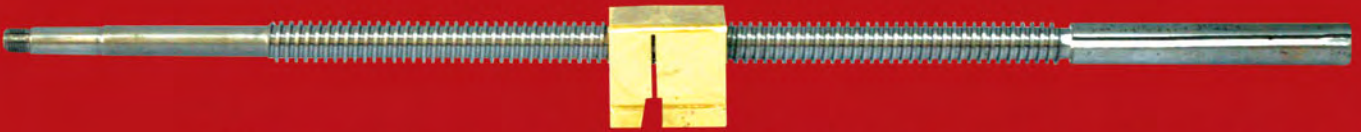

DİĞER TORNALARIN SPORT MİLLERİ / SPORT SHAFTS OF OTHER LATHES



Torna - freze - borvenk veher türlü üniversal makinaların vida, somun ve dişlileri istenilen her ölçüde üretilmektedir. *Screws, nuts and gears of lathes, cutters and borwerk machines and all kinds of universal machinery in all sizes as per order.*

# DİŞLİ ÇEŞİTLERİ / GEARS

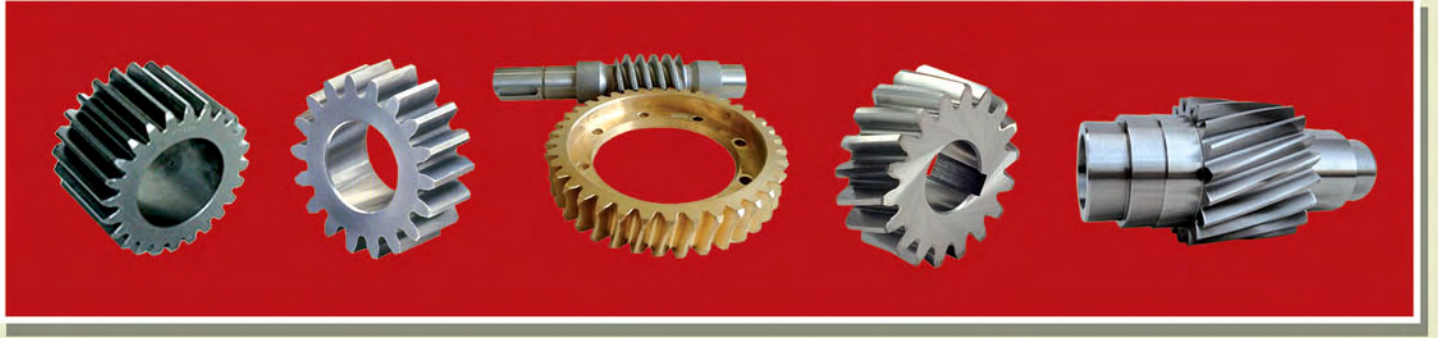

İç - dış - düz - helis - konik ve istenilen ölçüde özel dişli imalatı yapılmaktadır.  
*Special gears can be manufactured in internal, external, spur, helical and conical type and any size as per order.*

# KAMALI MİL VE YATAKLARI / TIMING SHAFT AND BEARINGS

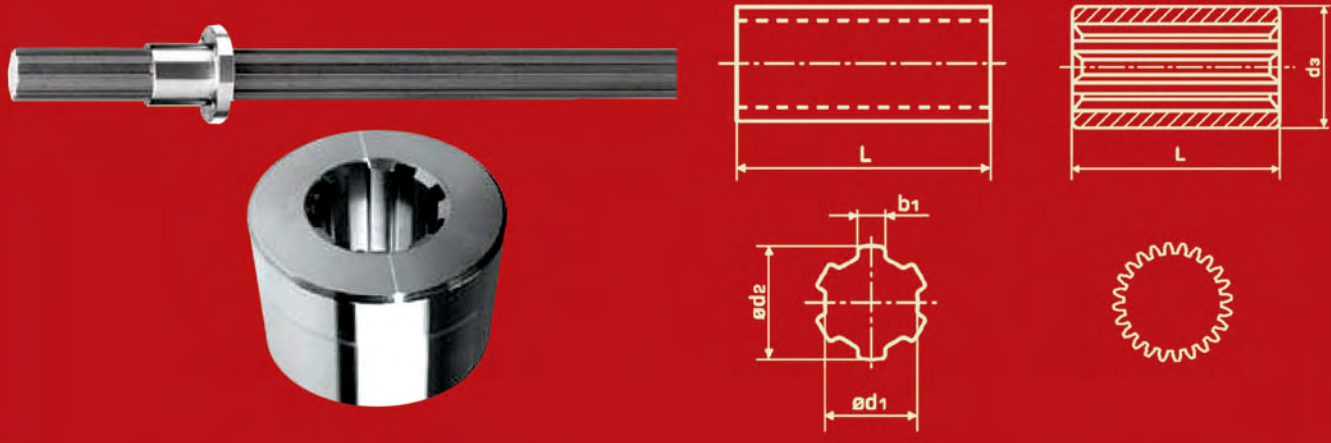

**Ø 16 MM - 210 MM ARASI 5000 MM  
BOYA KADAR KAMALI MİL, FREZE GEÇME MİLİ  
VE BURÇ İMALATI YAPILMAKTADIR.**

**TİMING SHAFT, CUTTER SHAFT  
AND BEARINGS CAN BE MANUFACTURED  
UP TO 5000 MM BETWEEN Ø 16 MM - 210**

## HELİS VE DÜZ KRAMAYER İMALATI HELICAL AND FLAT RACK MANUFACTURING

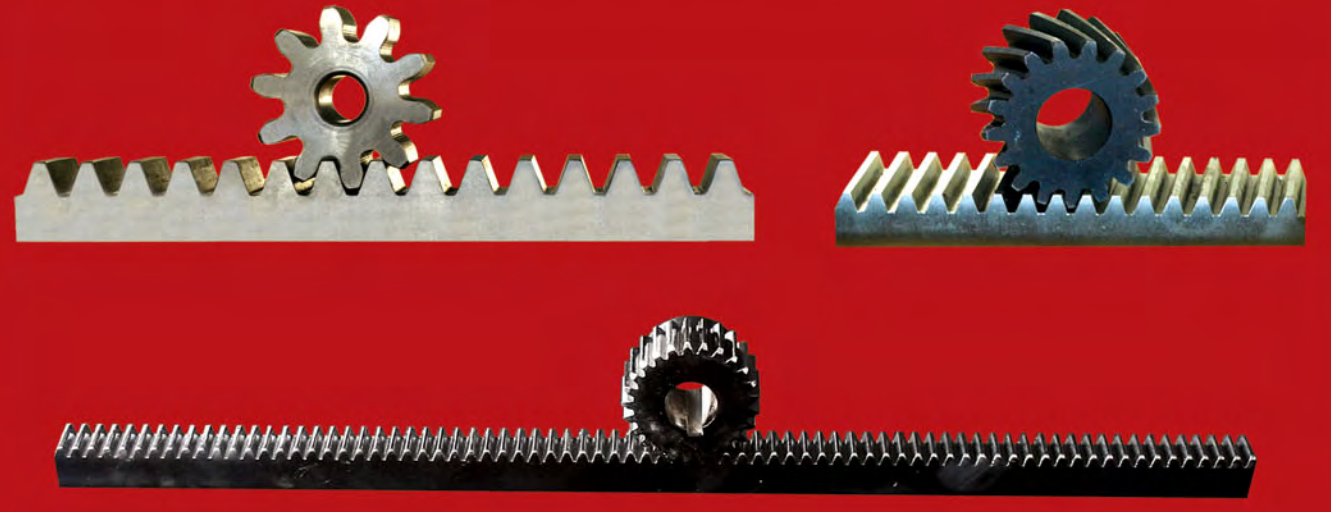

**0.5 MODÜL İLE 20 MODÜL ARASI  
DÜZ VE HELİS OLARAK İSTENİLEN BOYDA  
KRAMAYER VE PİNYON DİŞLİ  
ÇEŞİTLERİ ÜRETİLMEKTEDİR.**

**ANY SIZE OF RACK AND PINION GEAR  
İN FLAT AND HELICAL TYPES CAN BE  
MANUFACTURED BETWEEN 0.5  
MODULES AND 20 MODULES**

# ÖZEL REDÜKTÖRLER / SPECIAL REDUCERS

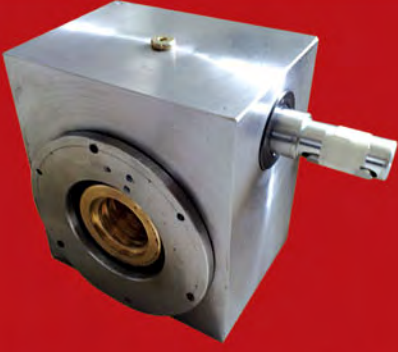

GÖBEKTEN VİDALI REDÜKTÖR  
CENTRIC SCREWED REDUCER

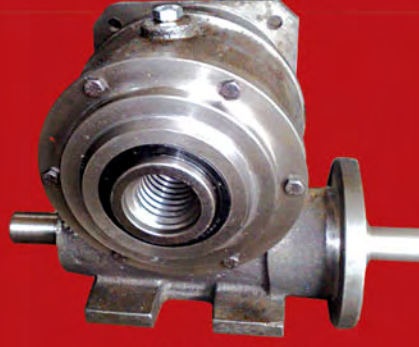

SFERO GÖVDE  
GÖBEKTEN VİDALI REDÜKTÖR  
NODULAR CAST CENTRIC  
SCREWED REDUCER

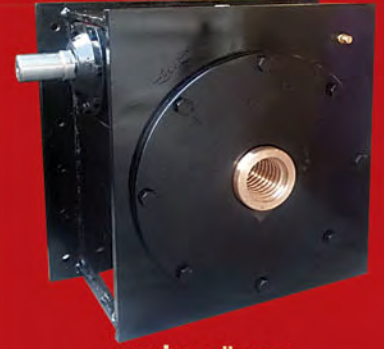

ÇELİK GÖVDE  
BARAJ KAPAK REDÜKTÖRÜ  
STEEL CENTRIC DAM  
SHUTTER REDUCER

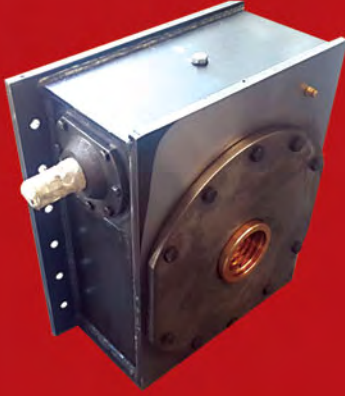

# YÜK TAŞIMA VE KALDIRMA SİSTEMLERİ LOAD BEARING AND LIFTING SYSTEMS



KRIKO 6 TONLUK  
6 TON JACK

KAPASİTE / CAPACITY: 6 TON  
AĞIRLIK / WEIGHT: 19 KG.



YÜK TAŞIMA ARABALARI 6 TONLUK

KAPASİTE: 6 TON - AĞIRLIK: 24 KG.  
SFERO DÖKÜM GÖVDE - ÇELİK ÇEKME TEKERLEK  
HER TEKERLEKTE ÇİFT RULMAN - KULLANIŞLI YÖN VERME KOLU  
MUKAVEMETLİ ELEKTROSTATİK BOYA - TAŞIMA KOLAYLIĞI

6 TON LOAD BEARING VEHICLES

CAPACITY: 6 TON - WEIGHT: 24 KG.  
NODULAR CAST - STEEL ROLLED WHEEL - DOUBLE BALL  
BEARINGS IN EACH WHEEL - USEFUL DIRECTION HANDLE  
HIGH-STRENGTH ELECTROSTATIC PAINT - EASE OF HANDLING



YÜK TAŞIMA  
ARABALARI  
12 TONLUK

KAPASİTE: 12 TON - AĞIRLIK: 48 KG.  
SFERO DÖKÜM GÖVDE - ÇELİK ÇEKME TEKERLEK  
HER TEKERLEKTE ÇİFT RULMAN  
KULLANIŞLI YÖN VERME KOLU  
MUKAVEMETLİ ELEKTROSTATİK BOYA - TAŞIMA KOLAYLIĞI

12 TON LOAD BEARING VEHICLES

CAPACITY: 12 TON - WEIGHT: 48 KG.  
NODULAR CAST - STEEL ROLLED WHEEL - DOUBLE BALL  
BEARINGS IN EACH WHEEL - USEFUL DIRECTION HANDLE  
HIGH-STRENGTH ELECTROSTATIC PAINT - EASE OF HANDLING

# MAKİNA PARKURU / MACHINE PARK



**CNC DİKİŞLEME / CNC STITCHING**  
X:1100 Y:600 Z:650 (4 EKSEN)



**CNC TORNA / CNC LATHE**  
12" X 1300

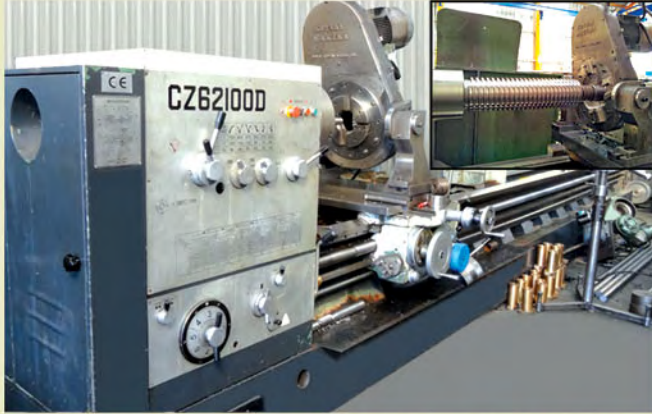

**SONSUZ VİDA MAKİNASI / WORM SCREW MACHINE**  
Ø 300 X 6000



**CNC TORNA / CNC LATHE**  
10" X 1500



**SONSUZ VİDA MAKİNASI / WORM SCREW MACHINE**  
Ø 150 X 4000



**RAINECKER KREMYER / RAINECKER RACK**  
450 x 4000 x 20 MODÜL



**SONSUZ VİDA MAKİNASI / WORM SCREW MACHINE**  
Ø 180 X 5000



**YATAY AZDIRMA / HORIZONTAL HOBGING MACHINE**  
Ø 220 X 5000

# MAKİNA PARKURU / MACHINE PARK



**AZDIRMA BIÇAK BİLEME**  
**HOBBING KNIFE SHAPING**



**VİDA TAŞLAMA / SCREW GRINDING**  
**Ø 300 X 600**



**BED FREZE / BED MILLING CUTTER**  
**3400 X 1000 X 1000**

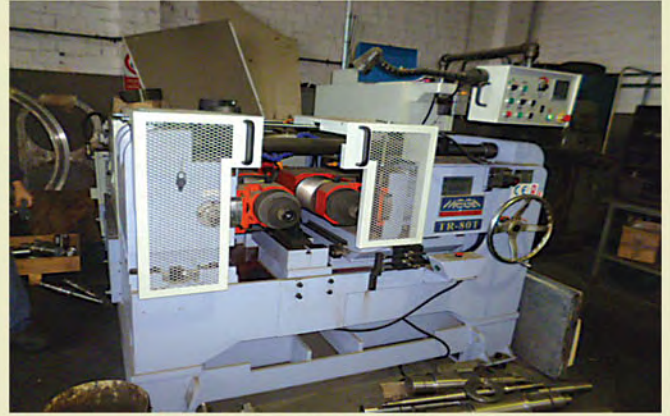

**OVALAMA / CRUMBLING**  
**80 TON**



**UNIVERSAL 2 M. TORNA**  
**UNIVERSAL 2 M. LATHE**



**AZDIRMA 300 X 6 MODÜL**  
**HOBBING 300 X 6 MODULES**



**VİDA HATVE KONTROL**  
**SCREW PITCH CONTROL**



**TAKIM BİLEME**  
**TOOL GRINDING**

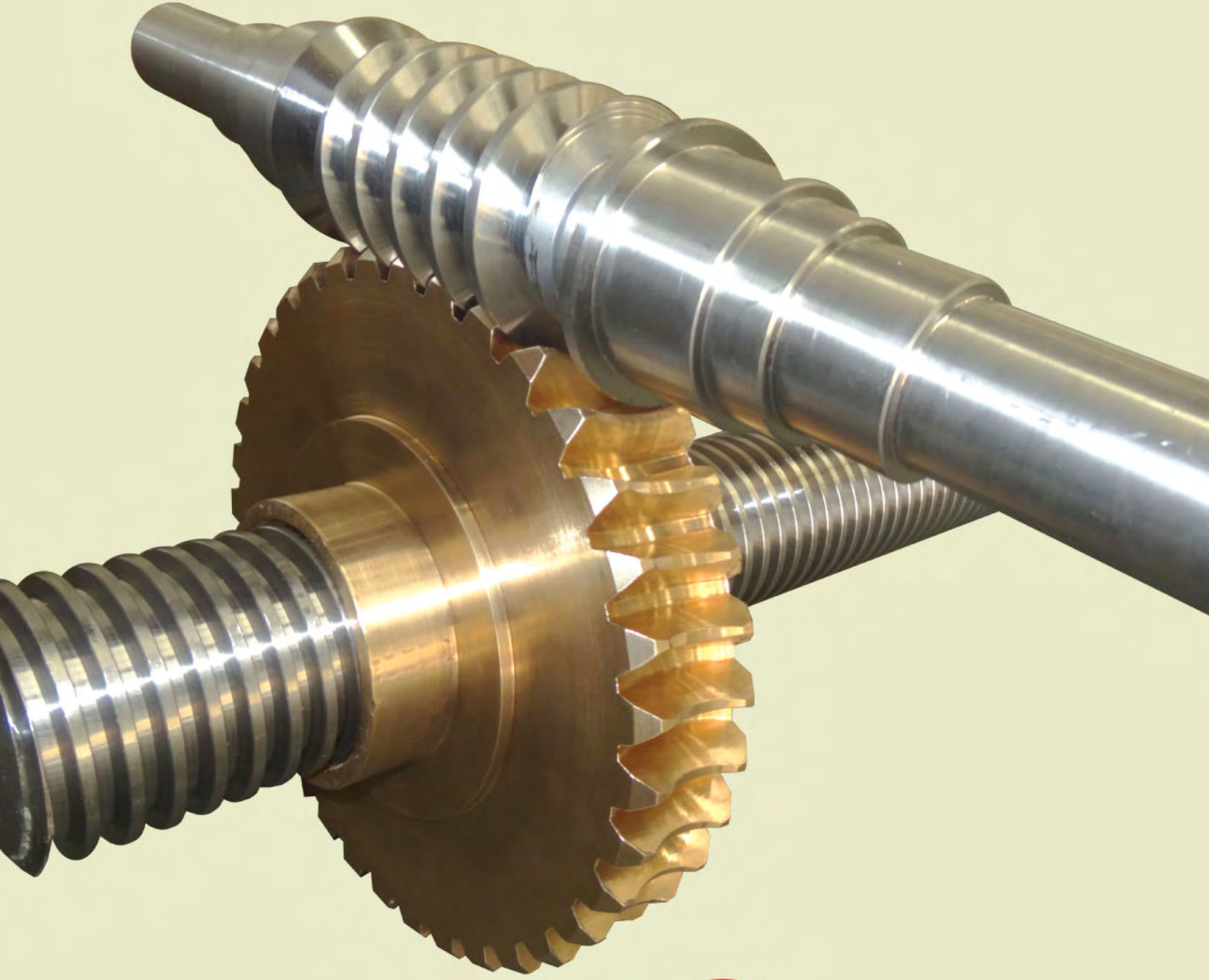

# KEYVAN

**MAKİNA VIDA İMALATI**

**MÜHENDİSLİK SAN. VE TİC. LTD. ŞTİ.**

**SANAYİ MAKİNALARI HAREKET VIDALARI**

**INDUSTRIAL MACHINERY MOVING SCREWS**

Ostim Organize Sanayi 1234. Sokak (eski 57. Sk.) No: 121 Ostim - ANKARA

Tel: (0.312) 385 94 26 - 27 • Fax: (0.312) 385 94 20

www.keyvanvida.com • www.keyvanmakina.com • info@keyvanmakina.com

